

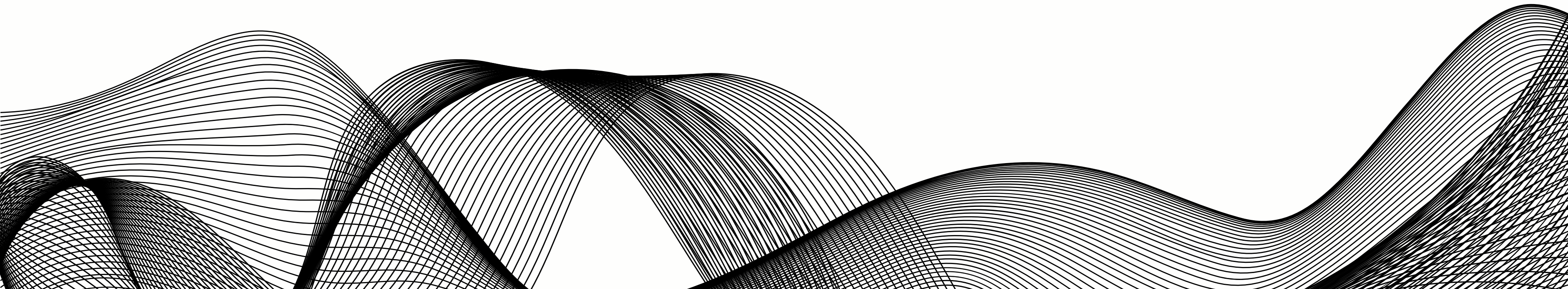

# WOTSO

Wood tech Solutions



- 
- Who we are
  - brifieng
  - Our business
  - Machine models
  - Technical support and assistance
  - Components



## WHO WE ARE

WOTSO is a leading company in Portugal providing professional machinery since 2012. We specialize in high quality machines, with a great technical support services response in the national market. All equipments we provide has a 1 or 2-year warranty, providing peace of mind to our customers.

Furthermore, WOTSO Portugal stands out for its excellence in providing technical assistance services. We offer a monthly or bi-monthly technical visit for our clients with no additional cost, carried out by specialized in-house technicians. With this support, we ensure that equipment remains fully operational and provides continuous high-precision performance.

Our products are designed to respond to the industry's most demanding requirements, with a very differentiating, profitable and highly productive activity performance.

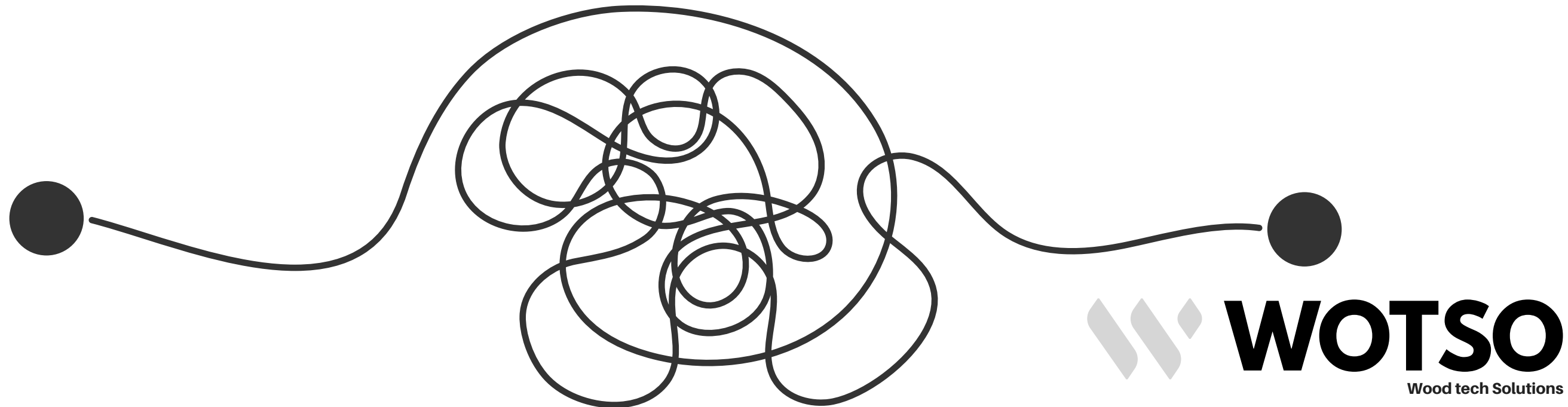

## — BRIEFING

WOTSO, a manufacturer and supplier of industrial machinery in the woodworking industry, brought with it vast knowledge, expertise and innovation, which became the basis of our transformation. Since the first day of this company, we have been growing with a wave of creativity and differentiation, which has rewarded us in every aspect of our operations.

Through a visionary vision, the group decided to create its own brand, as resellers and assistance service providers with knowledge and experience in different areas of the sector. This is how WOTSO was born. This dynamic movement not only propelled the company to new heights of success, but also revolutionized the way we serve and satisfy our customers by increasing their productivity and boosting their production lines through our automated solutions.



# OUR BUSINESS

---



## MACHINERY SUPPLY

WOTSO provides high quality industrial machinery, meeting the most demanding needs of our customers. Count on us to obtain accurate and reliable equipments.



## TECHNICAL ASSISTANCE AND SUPPORT

We offer specialized technical assistance and support. Our team is ready to support, with periodic visits at no extra cost (during the warranty period). This ensures the best possible operation of your equipment.



## COMPONENTS AND CONSUMABLES SUPPLY

WOTSO offers a wide variety of components and consumables to meet your needs. Count on us to find answers to all your production problems, we guarantee continuous and reliable performance of our equipment

# INDICADORES

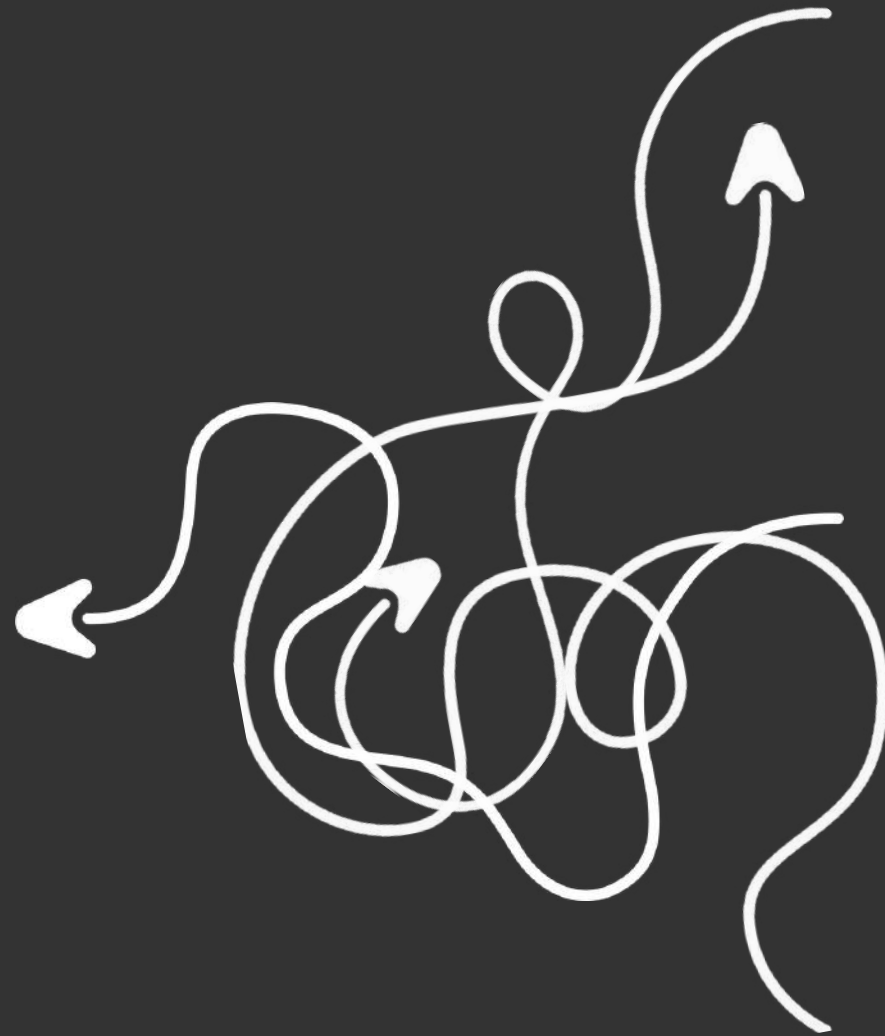

## PRODUCTIVITY

With a detailed analysis by our specialized technicians and commercial team, we always look for the best way to provide our customers with the best options available to respond to all their needs and substantially increase their production capacity.

## QUALITY

As we guarantee immense quality in our products and in order to provide a greater feeling of security and trust to our customers, we present ourselves as one of the only companies in the national market to establish periodic visits throughout the Warranty period in order to maintain the good condition and handling of the equipment.

## STRATEGY

We are positioned in the market as the brand with the best quality-price ratio. We develop strategic partnerships to enable greater coverage of the entire national territory, islands and others (Spain and Angola). Offering our partners and employees exceptional conditions in all businesses carried out, without ever neglecting the best and quickest after-sales service.

 1 year warranty on all machinery

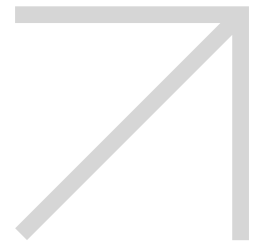

# Nesting Solutions

**W2-9 / W2-4 / W2 / W3 / W4 / W5 / WKC / WKD**



 1 year warranty on all machinery

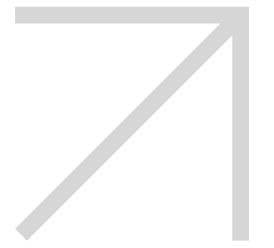

# CNC Machine Center Solutions

W2-4 / W2 / WKC / WKD







Six-sided multidrilling machine



1 year warranty on all machinery

# Multi Drilling Solutions

WHS SERIES

WHS1228C/WHSW1228C+1/WHS1228E





Special models for  
bevel edgebanding



1 year warranty on all  
machinery

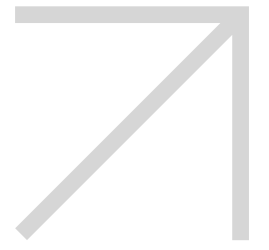

# Edgebanding Solutions



**WF / WV SERIES**

**461SK/463SK/583GX/683GI**

 1 year warranty on all machinery



# Optimized Panel Saw Solutions

**WPE /WPA SERIES**

**WPE280/WPE330/WPE380/WPA380/WPA380**







# Technical support and Assistance

## Monthly and quarterly

- Customized support contracts
- Scheduled periodic visits (monthly), throughout the equipment warranty and thereafter, unless requested by the customer.
- Team response within 24 hours of request.
- Possibility of remote analysis and assistance.



We offer quality monthly/bimonthly technical assistance.  
Count on our specialized team to keep everything in perfect condition.



# Components and Consumables

We offer a wide range of components and consumables for our equipment and adaptable to all other brands of equipment on the market.

## Consumables:

- Cutting tools
- Drilling Tools
- Milling tools
- Special bearings
- various pneumatic,
- electrical and mechanical materials.
- Inverters
- dust collectors
- others

## Components

- Spindles
- Robotic conveyors
- Return systems
- Energy and consumption management systems
- Integrated software

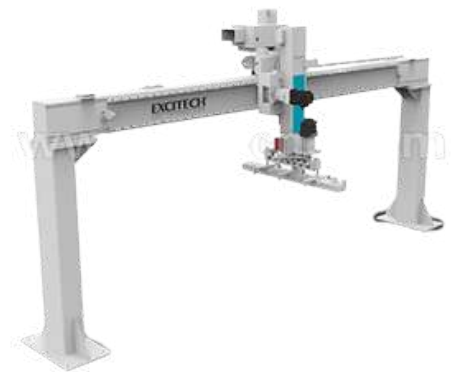

Rotary manipulator



Robotic arms



Transport roller/belt convoy



Returning systems



Inverters



Various Tools

# — SMART FACTORY LINE SOLUTION

“AN AUTOMATED PRODUCTION LINE IS A REVOLUTION IN MODERN INDUSTRY, SIGNIFICANTLY BOOSTING BUSINESS PRODUCTIVITY AND PROFITABILITY”

## SMART FACTORY SOLUTION

An smart production line consists of multiple automated workstations linked by a system (conveyors, robotic arms) that transfers parts from one station to the next.

## BENEFITS OF THE WOTSO SMART PRODUCTION LINE

- Low amount of direct labor.
- Best value for money offer
- High production rate (increased speed compared to human capabilities)
- Study and analysis of the location for better efficiency in the arrangement of equipment
- Guaranteed efficiency and profitability
- Accuracy and consistency
- Reduction of time and material waste
- High Security and Control over management

# Automated Production Line

COMPLETE SOLUTIONS FOR A SMART FACTORY

 All machinery has 2 year warranty

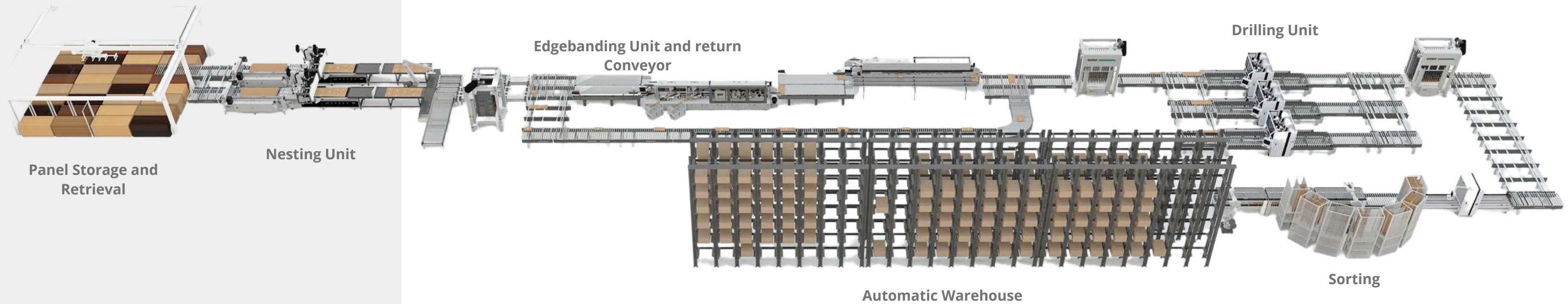
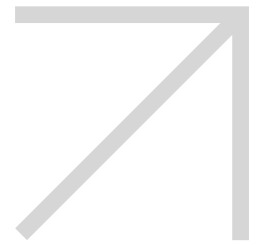



# Management of Production

Real time monitoring is made possible by integrating SCADA data collection and camera system.

All kinds of data including order status, production plan and progress are presentable through live feedbacks via industrial monitor screen, tablets or more devices.

- Real time machine production and process monitoring
- Reports any interruption immediately
- Embedded advanced planning and scheduling
- Facilitates lean management
- Connected systems help business grow with more effectiveness and competitiveness



## CENTRAL DE CONTROLO

Real time and accurate data collection and report propel lean management

Accessibility from mobile device makes management as mobile as you are

- Accurate Planning
- Optimized machine assignment and production
- Intelligent registration and arrangement in queue
- Machine capacity monitoring
- Synchronization with production management system
- Broken parts and rework can also be integrated into planning.

WOTSO Manufacturing Execution System is an integrated solution that monitors, reports, and communicates all manufacturing related information including machinery status, order status, production data, capacity, production planning and scheduling, and more. All information is accessible to relevant parties so they can make informed decisions, manage performance on different levels, and reach new and industry-leading levels of management.

## ARMAZENAMENTO DE PAINÉIS



Rational utilization of shop floor that combines material storage, manufacturing equipment and logistics functionalities. Planning ahead of production, stock and stock all in one.



## SISTEMA DE CLASSIFICAÇÃO



Highly flexible solution for temporary storage, sorting, sequencing and batching that greatly improves turnover. Available in both vertical and horizontal styles to accommodate various dimensions.

Robots pick-up and transportation is not only efficient but also error-free.

## CENTRAL DE CONTROLO PACOTES



Planning and sorting according to parts, and hardware before packaging.

- System dispatches packaging tasks and sorting status to specific operators or work stations.
- Supports various packaging algorithm.
- Generates streamlined packaging algorithm.
- Orchestrates single piece, batch and complex workflows.
- Communicates with WOTSO MES.

## CONTROLO DE SISTEMA ARMAZENAMENTO



- Ease of operation
- Real time update of stock status and reports
- Shipping and receiving management



# WOTSO

**Wood tech Solutions**

Rua Seixo, lote C 4580-630  
Vila Cova de Carros | Paredes

[geral@wotso.eu](mailto:geral@wotso.eu)

(+351) 915 372 883

